

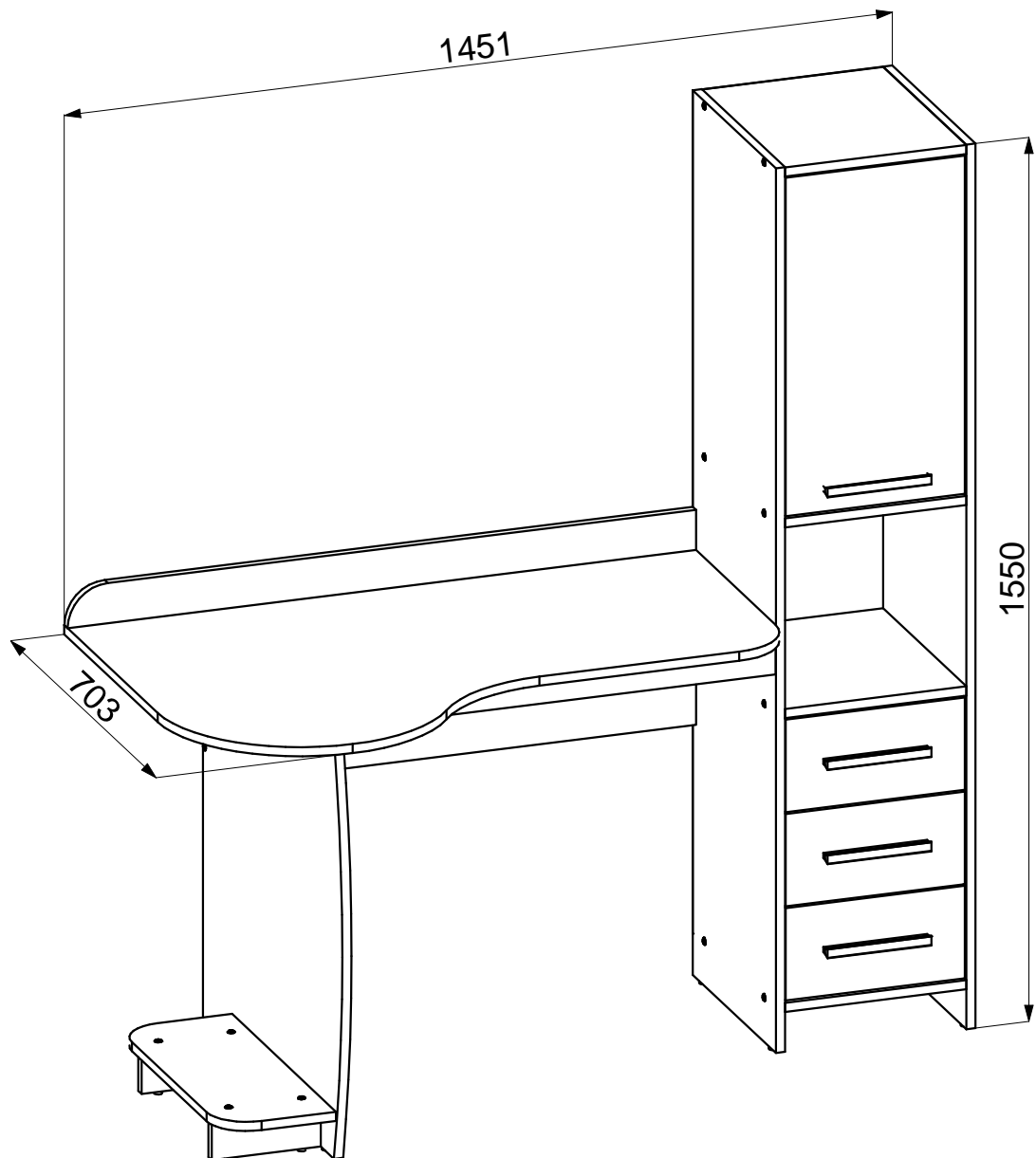

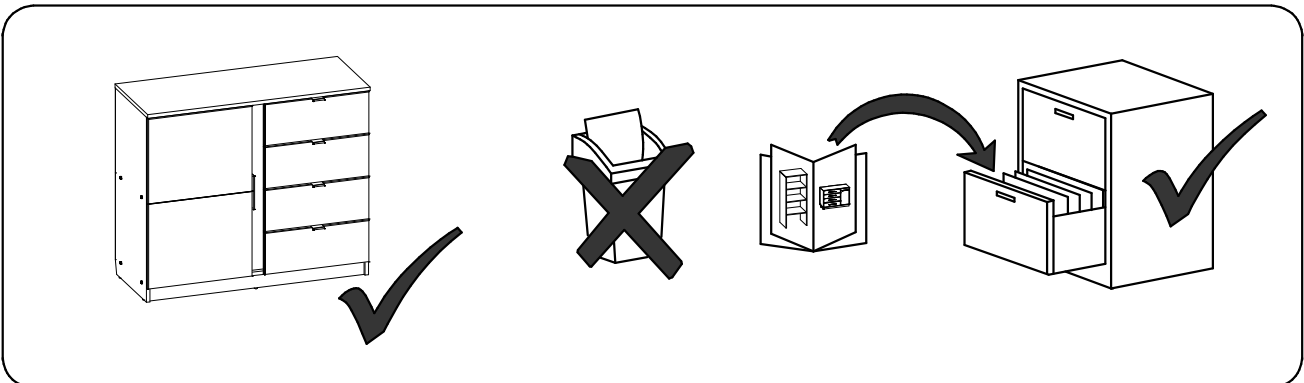

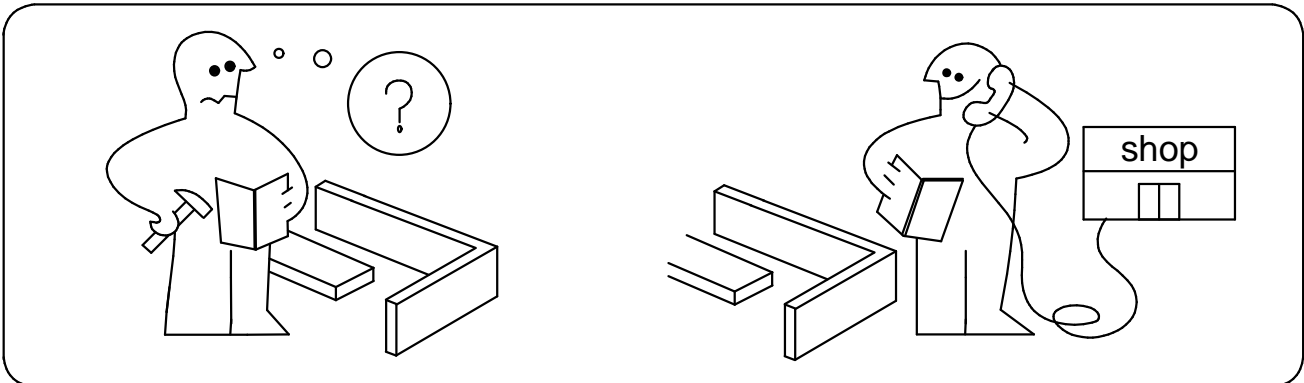

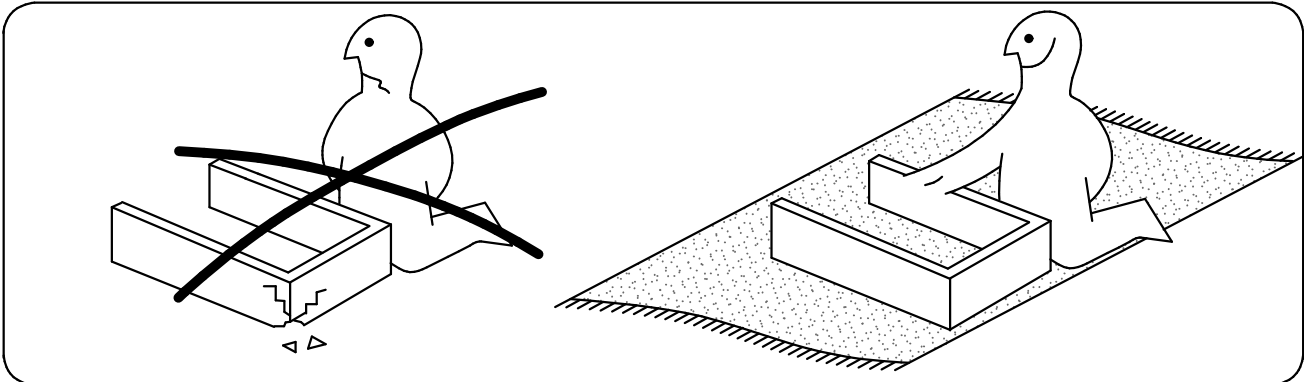

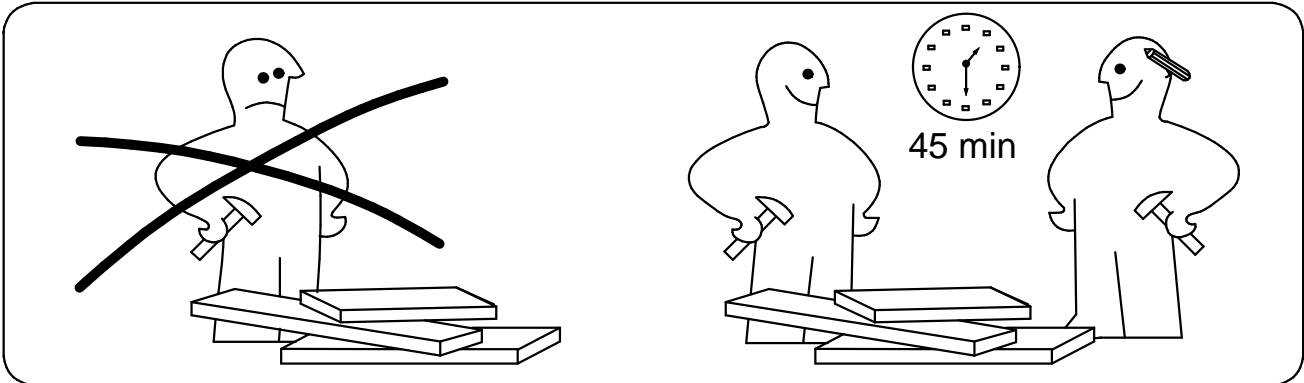



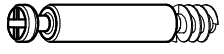





# Бюро Волино

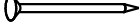
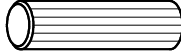

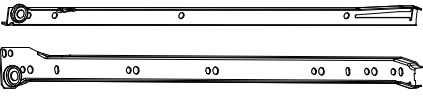

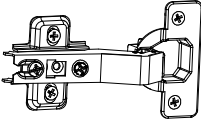

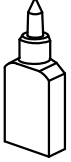
 Ø6,3x50 mm <b>A1 x 31</b>	 Ø12 mm <b>A2 x 26</b>	 4 mm <b>A3 x 1</b>	 Ø15x12 mm <b>B1 x 2</b>	 Ø5x44 mm <b>B2 x 2</b>
 Ø20 mm <b>B3 x 2</b>	 Ø12x3 mm <b>C x 3</b>	 Ø3x16 mm <b>D1 x 18</b>	 Ø4x16 mm <b>D2 x 26</b>	 Ø4x20 mm <b>D3 x 3</b>
 Ø4x30 mm <b>D4 x 6</b>	 Ø4,2x32 mm <b>D5 x 8</b>	 Ø1,6x25 mm <b>F x 102</b>	 Ø8x36 mm <b>G x 58</b>	 <b>H x 4</b>
 <b>K x 3</b>		 Ø5x16 mm <b>L x 4</b>	 <b>M x 2</b>	 Ø15 mm <b>N x 10</b>
 50g <b>R x 1</b>				

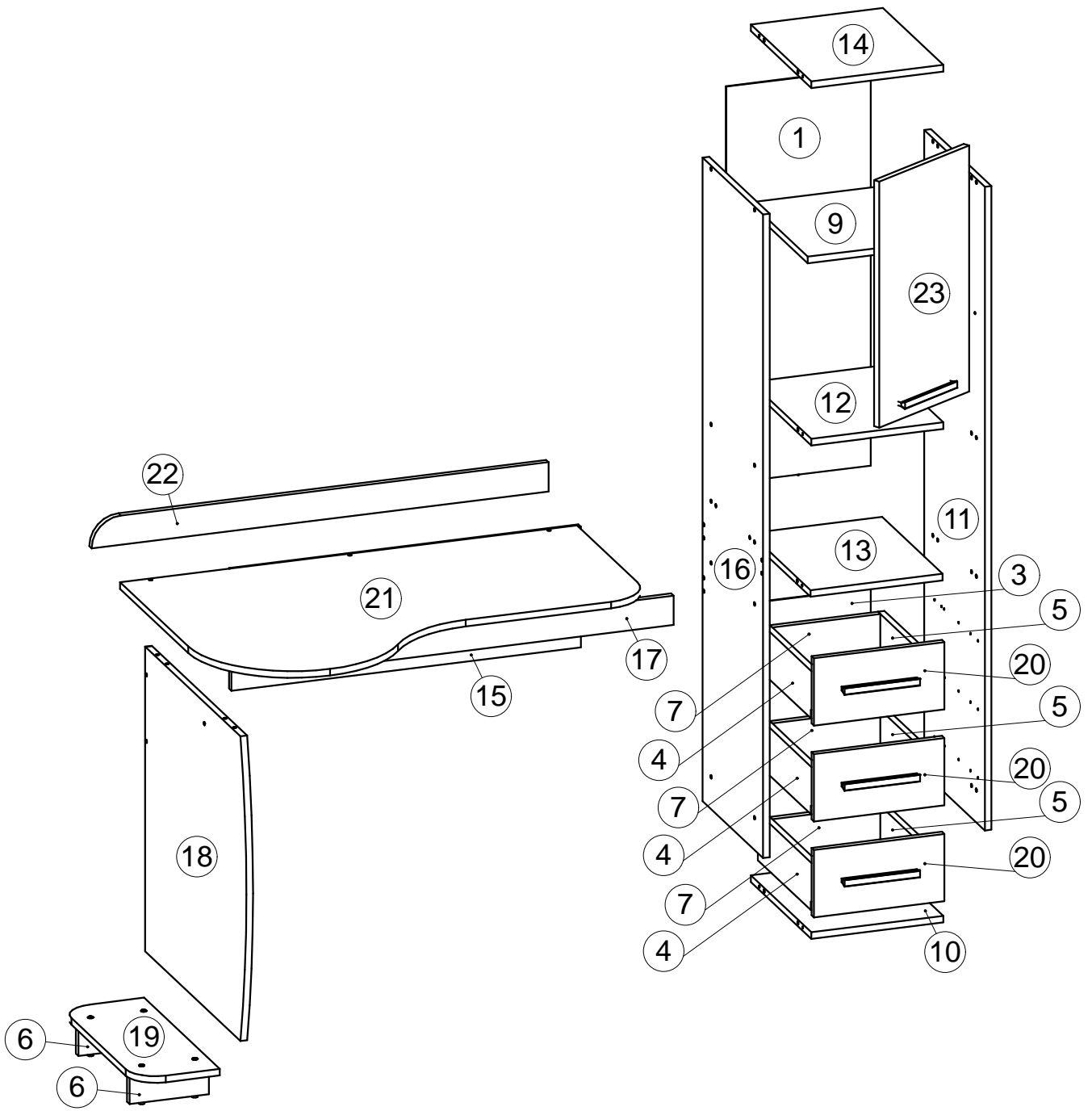

### Box 1/2

956x348x3 mm

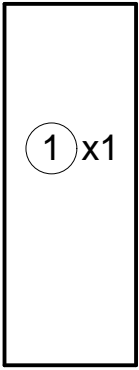

290x348x3 mm

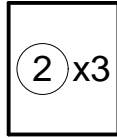

522x348x3 mm

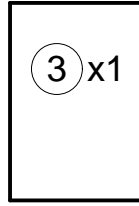

350x100x16 mm

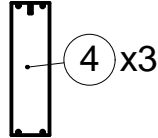

190x70x16 mm

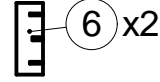

260x100x16 mm

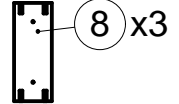

350x100x16 mm

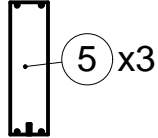

318x400x16 mm

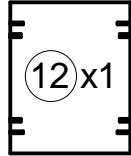

161x313x16 mm

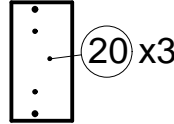

260x100x16 mm

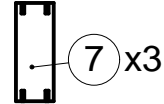

382x318x16 mm

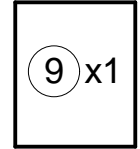

318x400x16 mm

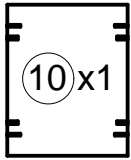

1550x400x16 mm

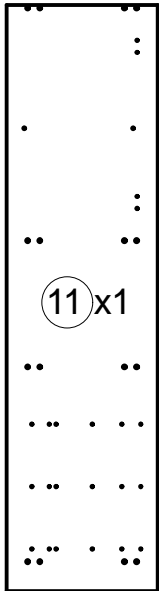

318x400x16 mm

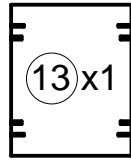

842x290x16 mm

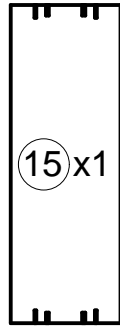

1550x400x16 mm

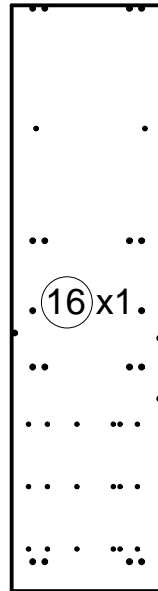

842x70x16 mm

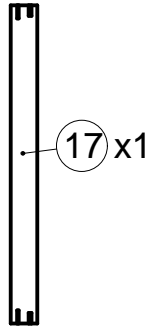

1100x70x16 mm

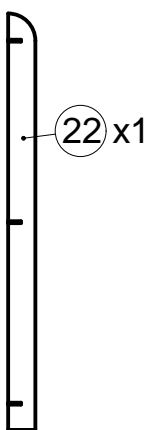

318x400x16 mm

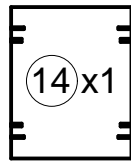

Fittings & Tools

592x313x16 mm

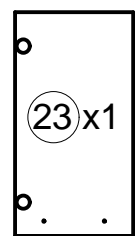

### Box 2/2

1100x700x16 mm

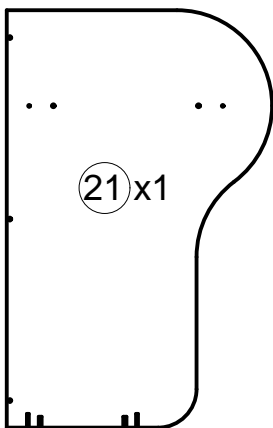

734x670x16 mm

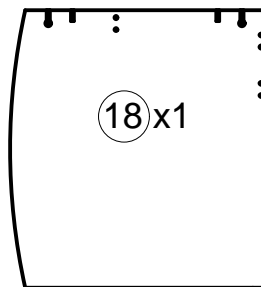

500x200x16 mm

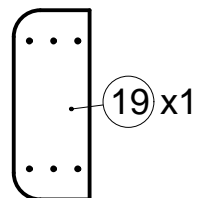

1

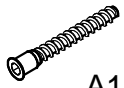

A1 x 16



A2 x 16



A3 x 1

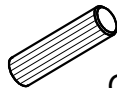

G x 16

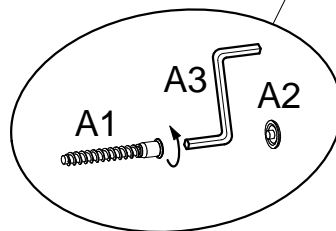
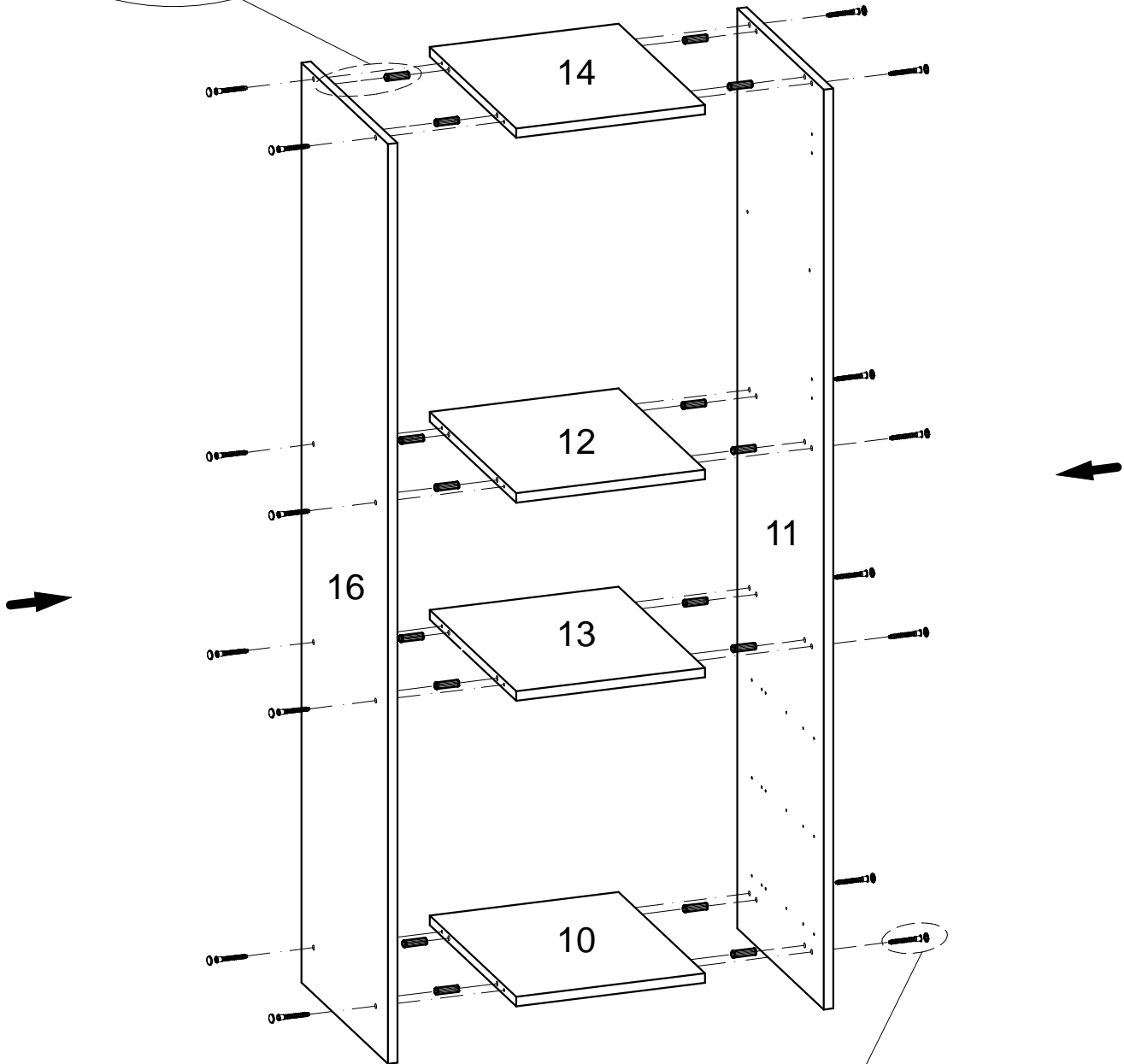
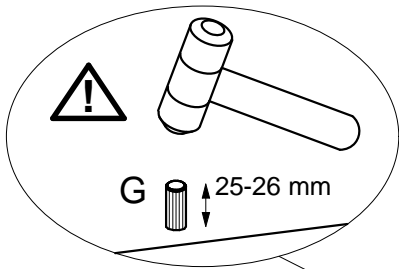
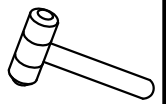

2



C x 3



D3 x 3

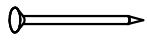

F x 42

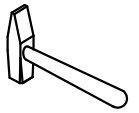
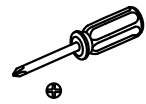

⚠ XX=YY≅90°

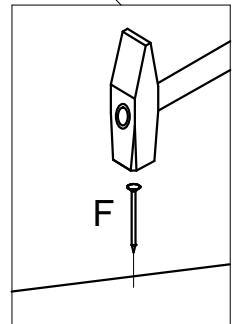
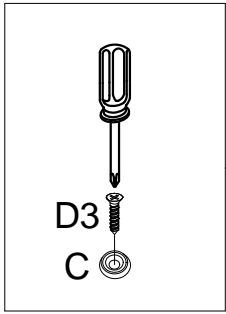
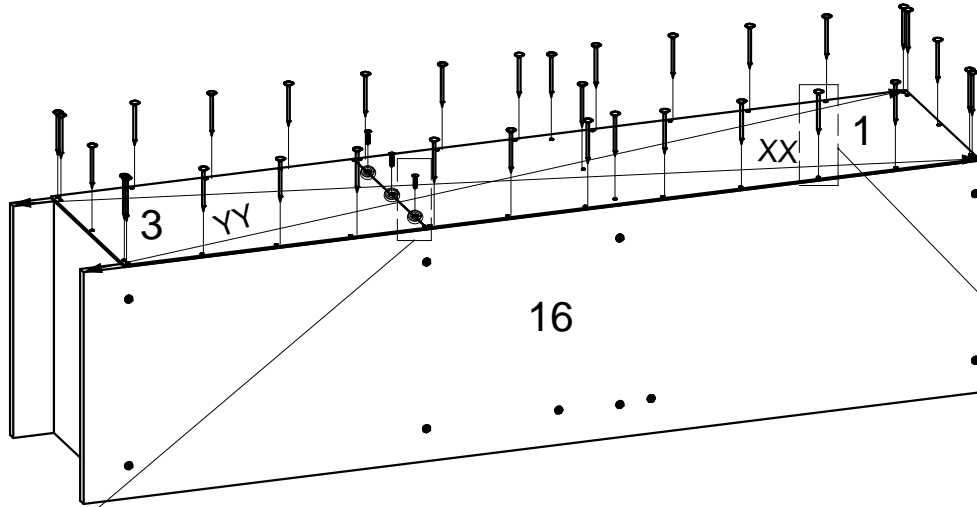

3

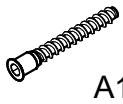

A1 x 3



A3 x 1

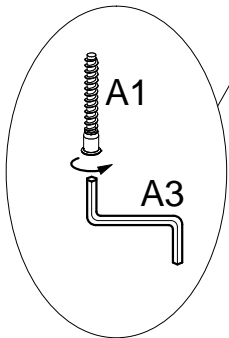
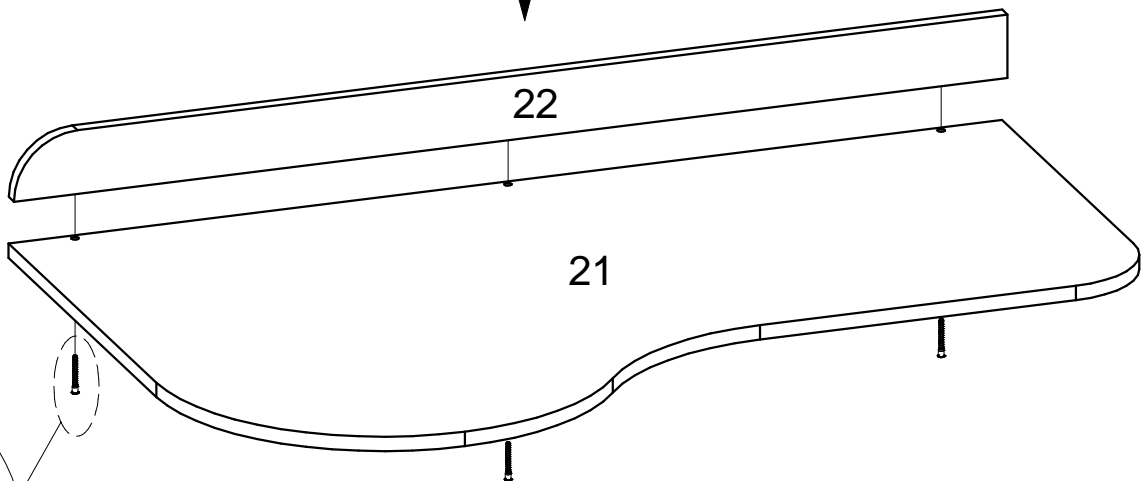

4

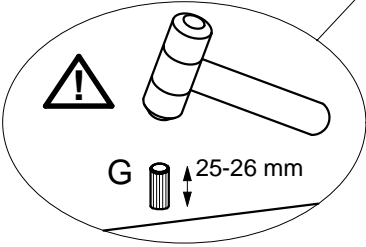
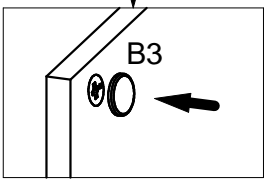
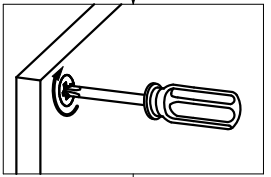
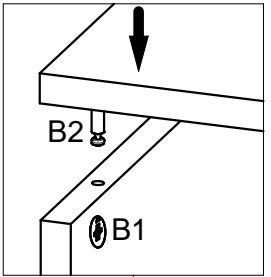
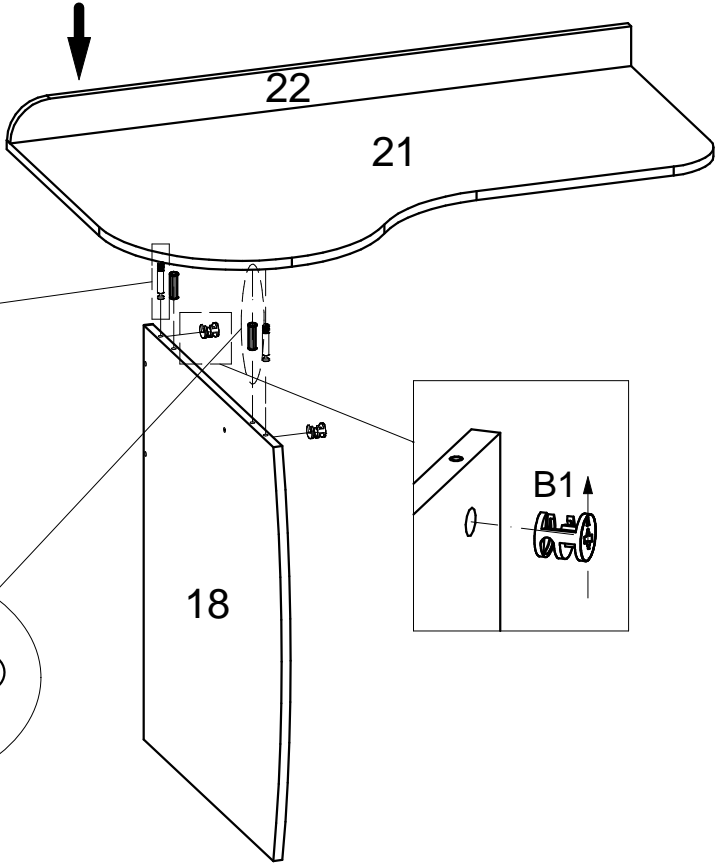
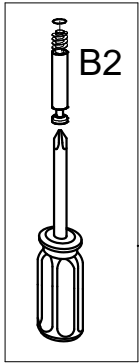
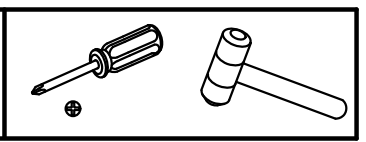
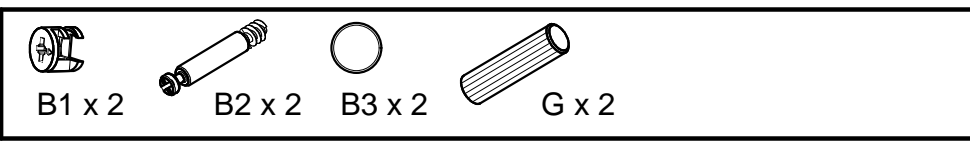

5

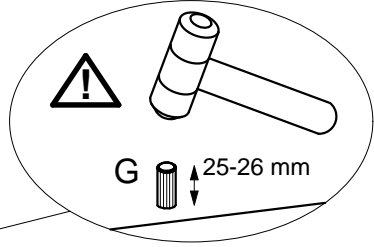
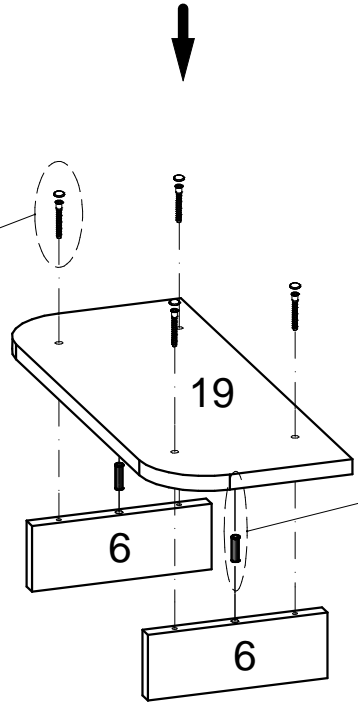
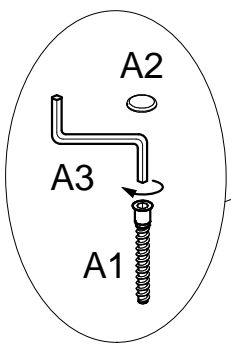
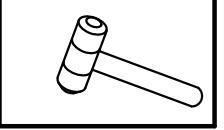
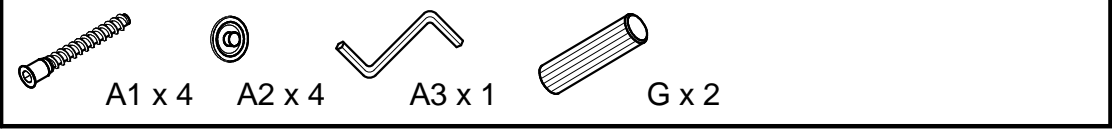



6



A1 x 8



A2 x 6



A3 x 1



D2 x 4



M.1 x 2

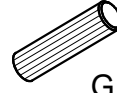

G x 8

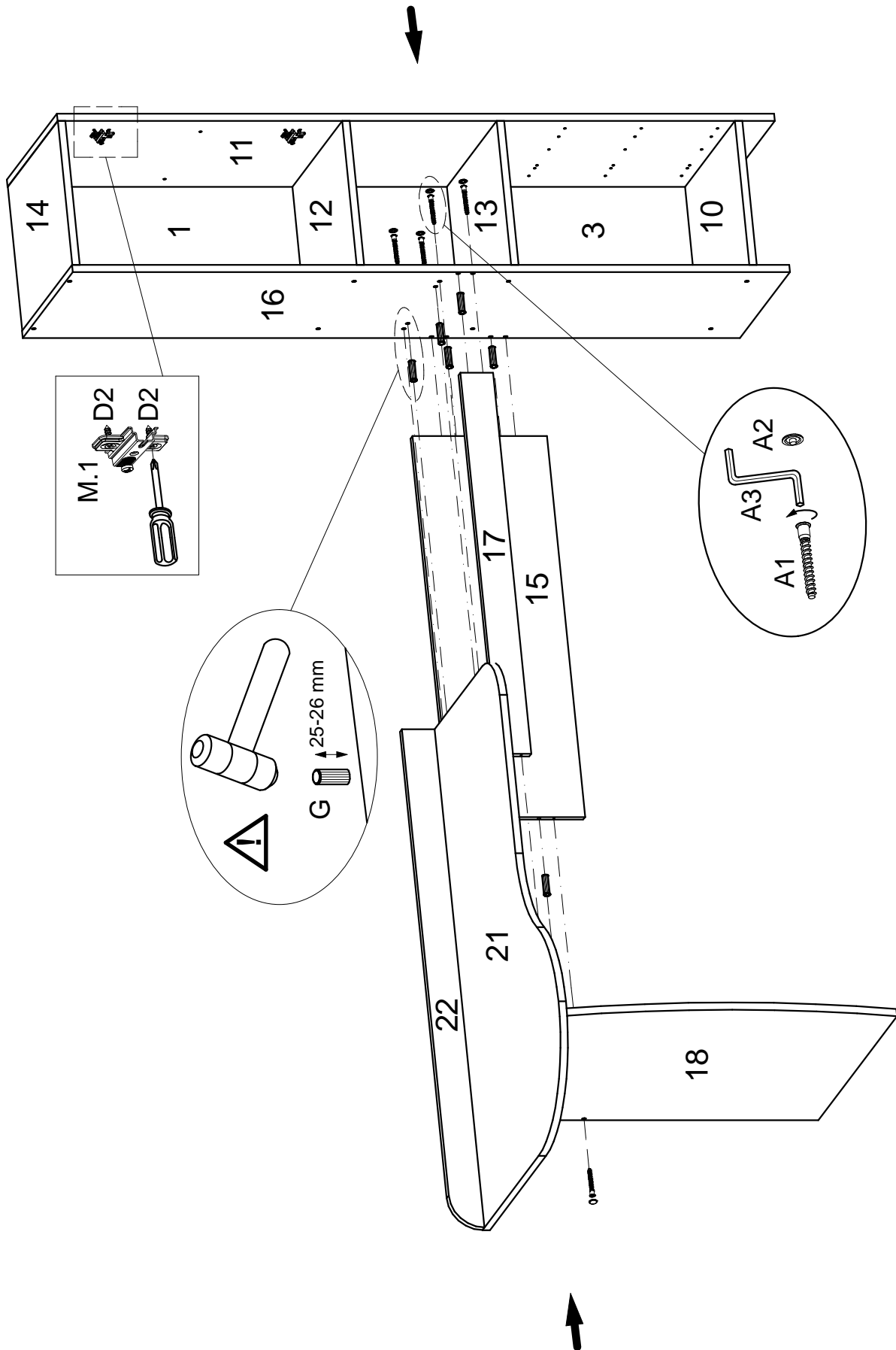
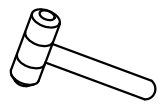
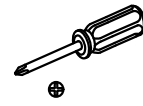

7

- D1 x 18
- D2 x 4
- D5 x 2
- H x 1
- L x 4
- M.2 x 2
- M.2 x 2
- K1 x 3
- K2 x 3

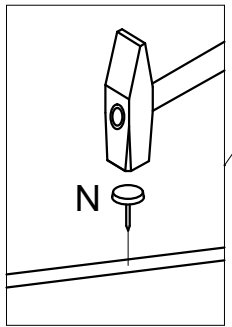
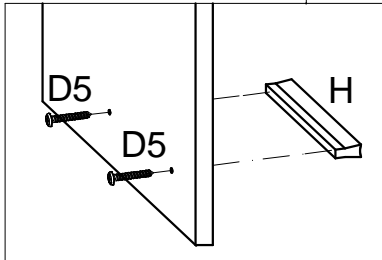
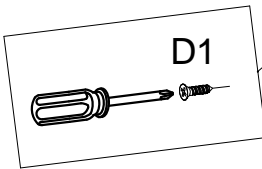
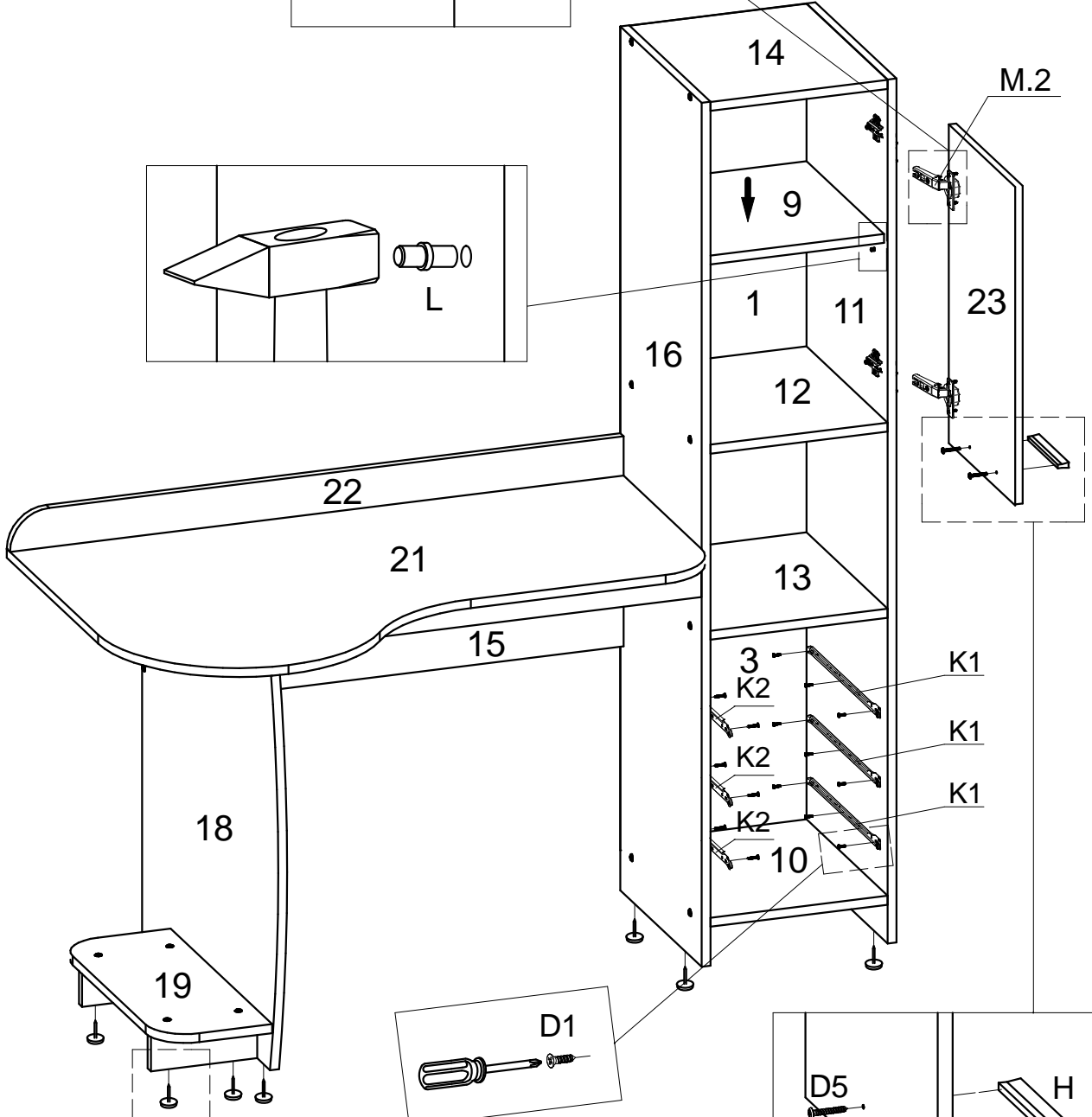
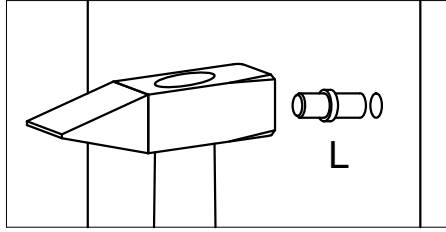
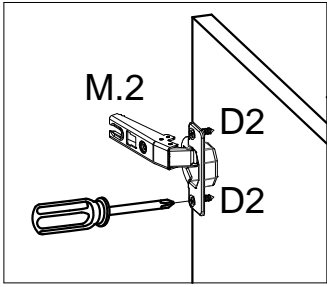
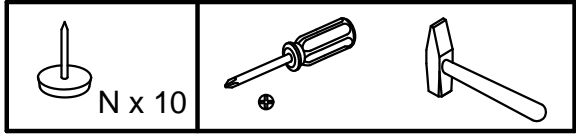

8

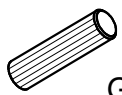

G x 24



R x 1

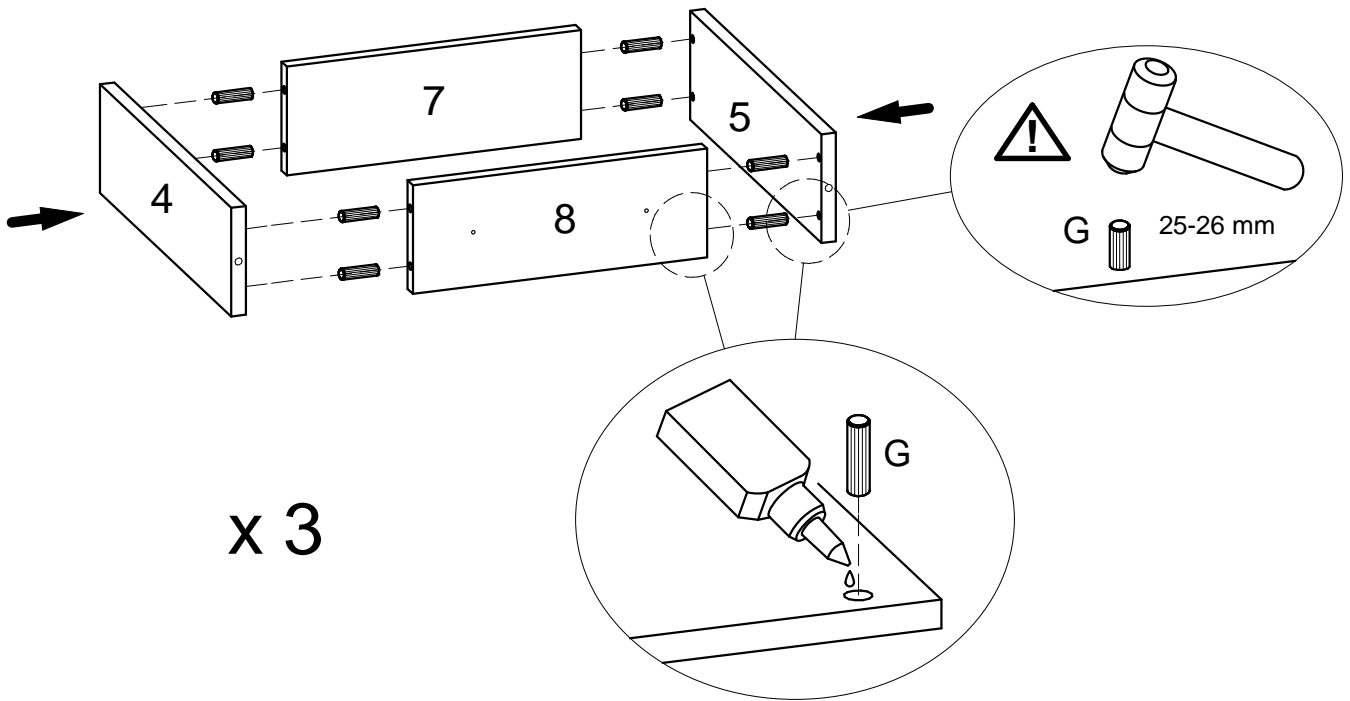
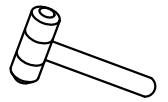

9

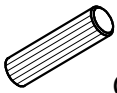

G x 6

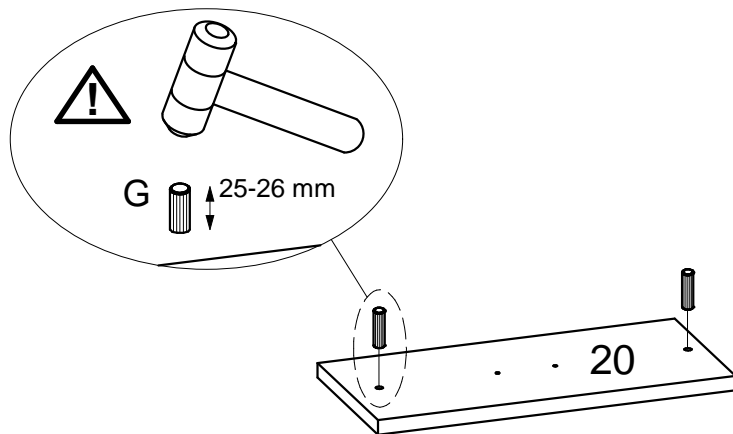
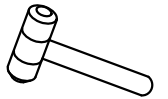

10



D5 x 6



H x 3

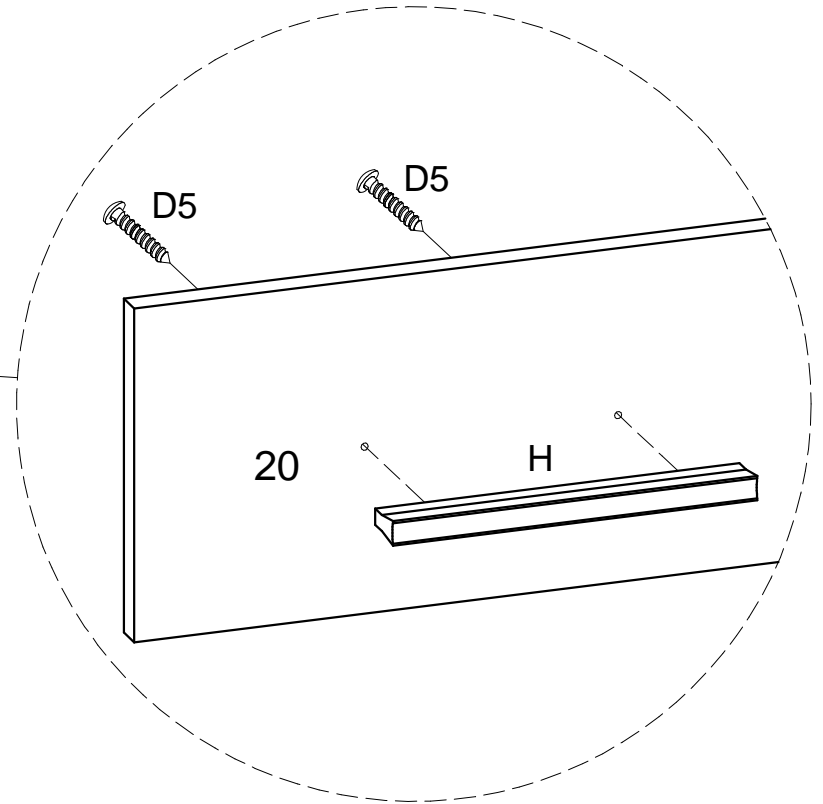
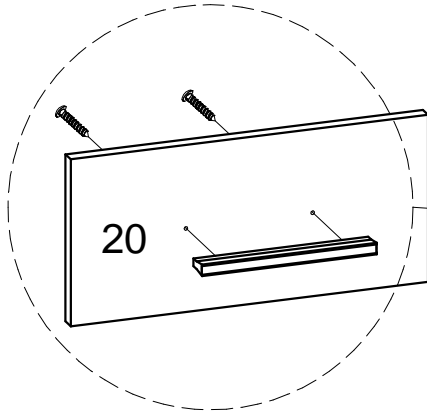
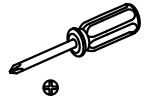

x 3

11

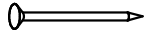

F x 60

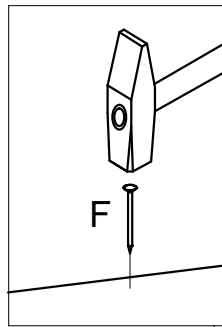
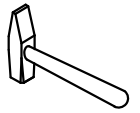

⚠ XX=YY≅90°

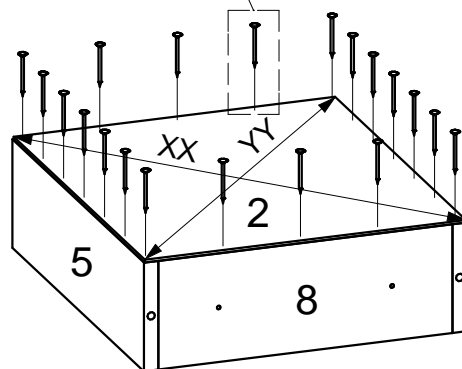

x 3

12



D2 x 18

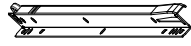

K3 x 3

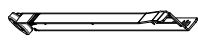

K4 x 3

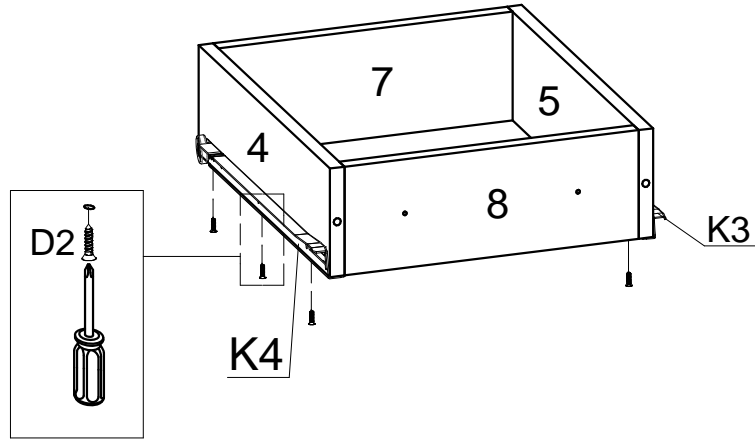
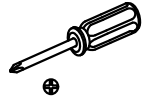

x 3

13



D4 x 6

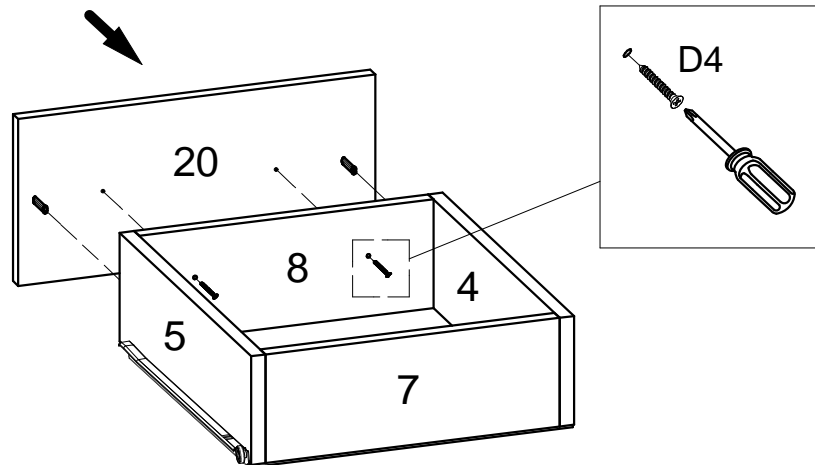
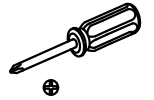

x 3

14

